

Product Guide**C 2090** 60W 100V Line IP66 Rated High Efficiency Horn Speaker

C 2090 60W 100V Line IP66 Rated Horn Speaker

- ✓ High output power model
- ✓ IP66 Weather resistant
- ✓ UV stabilised ABS construction
- ✓ Superb speech & music reproduction
- ✓ Excellent sound dispersion
- ✓ EWIS line monitoring system compatible
- ✓ Ideal for high ambient noise environments



Application

This high power speaker is ideal for installations with very high ambient noise levels, such as in mine sites, industrial plants, large factories and workshops.

About Redback® Speaker Drivers

Each horn speaker has been specifically engineered to ensure a wide frequency range and dispersion angle, plus a high sound pressure level (SPL) ensuring excellent music and speech intelligibility, which is highly desirable.

Redback® drivers exhibit optimum frequency response and efficiency for BGM & paging applications.

Redback® drivers are subject to strenuous factory testing reducing the risk of unit failure or performance reduction over time.

Installation Guidelines

The C 2090 is a 100V line horn speaker designed for direct connection to a commercial amplifier with 100V output. It is fitted with a 300mm 5 core cable for loop through connection.

Supplied rust free aluminium wall bracket, nickel plated hardware and weatherproof cable gland.

The enclosure is surprisingly compact for easy wall mounting.

The neutral grey RAL 7035 colour of C 2090 provides an architecturally unobtrusive finish to virtually any installation.

Product Guide

C 2090 60W 100V Line IP66 Rated High Efficiency Horn Speaker



Dimensions & Transformer Detail

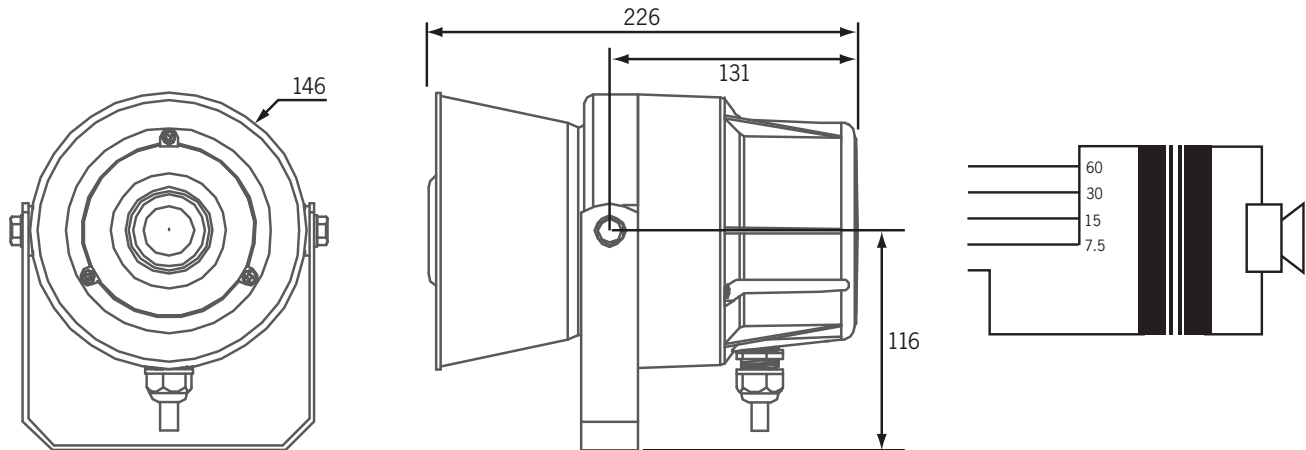

Specifications

Electrical

Power taps:	7.5, 15, 30, 60W
SPL 1W @ 1m:	103dB @ 1kHz (+/- 2dB)
SPL Max Tap @ 1m:	120dB @ 1kHz (+/- 2dB)
Frequency response:	340Hz-10kHz
Connection:	5 core cable
Dispersion 1kHz/4kHz:	360° / 40°

Mechanical

Dimensions:	146Ø x 226D mm
Overall weight:	2.7kg

Environmental

Material:	High impact ABS with UV inhibitors
Operating temperature:	-25°C to +70°C
Relative humidity:	< 95%

Frequency Response (SPL 1W @ 1m)

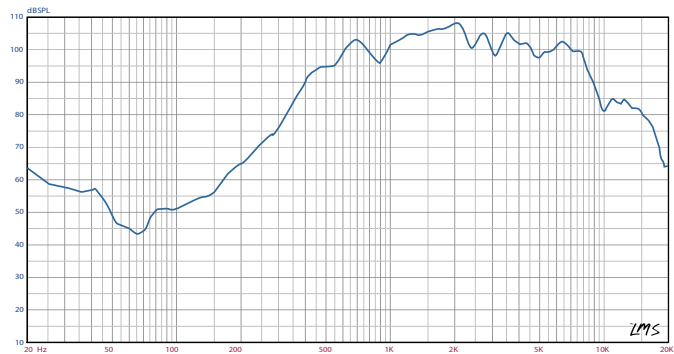

Architectural Specifications

The high power horn speaker shall operate at 100V and have power taps of 60W, 30W, 15W, and 7.5W. Power settings shall be made by 5 core cable selection. It shall have SPL of 103dB measured at 1W @ 1m. Maximum SPL shall be 120dB. It shall have a frequency response of 340Hz to 10 kHz. It will be fitted with aluminium wall bracket and nickel plated hardware. The speaker body shall be RAL7035 colour and made of UV stabilised ABS with a weatherproof ingress protection rating of 66. The horn speaker shall be a REDBACK model C 2090.